

C1

by Wipsar Sunu Brams Dwandaru

Submission date: 01-Oct-2020 08:46AM (UTC+0700)

Submission ID: 1401869369

File name: C1.pdf (180.25K)

Word count: 4063

Character count: 18569

Phase Diagrams and Current Density Profiles of the Totally Asymmetric Simple Exclusion Process in Two Dimensions, for a Three-Way Junction

Rini Septiana¹, Annisa Indriawati², and Wipsar Sunu Brams Dwandaru^{3*}

1. Universal School Kelapa Gading, Jakarta Utara 14240, Indonesia

2. Graduate School, Universitas Gadjah Mada, Yogyakarta 55281, Indonesia

3. Department of Physics Education, Faculty of Mathematics and Natural Sciences, Universitas Negeri Yogyakarta, Yogyakarta 55281, Indonesia

*E-mail: wipsarian@uny.ac.id

Abstract

This study explores a dynamical model called the totally asymmetric simple exclusion process (TASEP) in two dimensions (2D). An open boundary condition is specified for the model, and sequential updating dynamics are used as the dynamical rule. The system studied is a discrete 2D system of lattice sites, which are modified into a three-way junction. Two cases are considered: a three-way junction with two entrances and one exit, and a three-way junction with one entrance and two exits. The density and current density of the system are determined numerically, such that a phase diagram is obtained. The continuity equation describing the dynamics of particles in the system is solved by using a simple Euler method. The results show that the density and current density profiles, as functions of the lattice sites, are determined by the input and output rates at their boundaries. Moreover, the density phases obtained are combinations of the density phases of the TASEP, which yield a rich phase diagram.

Abstrak

Diagram Fase dan Profil Rapat Arus Totally Asymmetric Simple Exclusion Process dalam Dua Dimensi untuk Sebuah Pertigaan Jalan yang Searah. Telah diteliti sebuah model dinamik yaitu *the totally asymmetric simple exclusion process* (TASEP) khususnya dalam dua dimensi (2D). Syarat batas yang digunakan untuk model ini adalah syarat batas terbuka. Aturan dinamika yang digunakan adalah aturan dinamika *sequential updating*. Sistem yang dipelajari adalah sebuah sistem diskrit berupa kekisi dalam dua dimensi. Sistem ini dimodifikasi menjadi bentuk pertigaan (*junction*) yang searah. Dua kasus yang dipelajari dalam penelitian ini adalah pertigaan dengan dua pintu masuk dan sebuah pintu keluar, dan pertigaan dengan satu pintu masuk dan dua pintu keluar. Nilai rapat arus partikel dalam sistem tersebut ditentukan secara numerik sehingga dihasilkan diagram fase. Persamaan kontinuitas untuk menggambarkan dinamika partikel dalam sistem diselesaikan menggunakan metode Euler sederhana. Hasil numerik menunjukkan bahwa profil kerapatan dan rapat arus partikel dipengaruhi oleh syarat batas, yaitu laju masukan (*input rate*) dan laju luaran (*output rate*). Selain itu, fase kerapatan yang diperoleh merupakan kombinasi dari fase kerapatan untuk TASEP sehingga dihasilkan diagram fase yang kaya akan fase kerapatan.

Keywords: current density, density, input rate, output rate, phase diagram, TASEP in 2D

1. Introduction

A popular particle hopping model that has become a reference model for studying non-equilibrium-driven systems [1,2] is the totally asymmetric simple exclusion process (TASEP) [3,4]. TASEP is a driven system in which particles occupying one-dimensional lattice sites jump to their nearest right-hand neighbor site, provided

that there is no other particle occupying that site. The jump occurs in to the right only. This model was originally applied to study the polymerization kinetics of nucleic acid templates [5,6]. Since then, it has been used as a standard tool for studying one-dimensional transports [7-9] and the biological motions of motor proteins [10].

The TASEP is specified by a dynamical rule and boundary conditions [11,12]. The boundary condition used is that of open boundaries. Under this condition, each boundary in the lattice system is given a reservoir that acts as an entrance for particles, as well as another reservoir that acts as an exit. Particles may only enter and go out of the lattice sites through the entrance and exit, respectively. This type of boundary condition produces interesting phases, which show the inhomogeneity of the particle density profiles.

The dynamical rule applied in this study is called sequential updating. For lattice systems, the dynamical rule prescribes the movement of particles from one site to another on a lattice. The jumping process is specified by a quantity called the hopping rate, expressed as $k_{i(i+1)}(t)$. $k_{i(i+1)}(t)$ is the probability of a particle jumping from lattice site i to site $i+1$ at time t . An example of the sequential updating dynamics can be observed in Figure 1.

As depicted in Figure 1, at time t , a site is chosen randomly with the probability $1/(N+1)$, where N is the total number of lattice sites. In this case site $i = 4$ is chosen, but there is already a particle at the site.

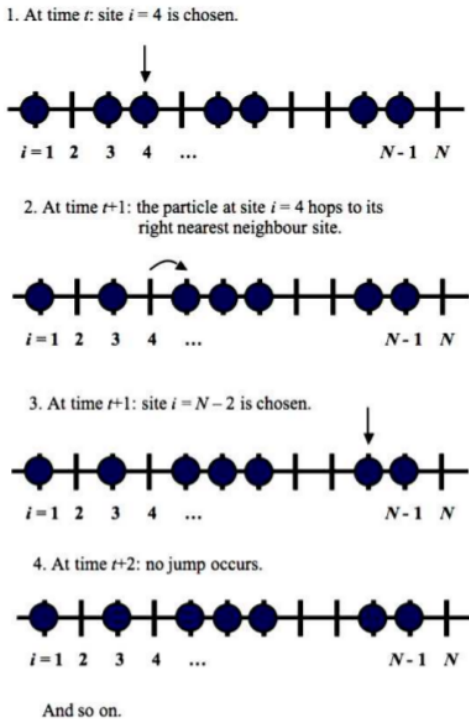

Figure 1. An Example of the Sequential Updating Process of the TASEP (Taken from [12])

However, no particle occupies site $i = 5$. Therefore, at time $t + 1$, the particle at the chosen site may jump to site $i = 5$ at the hopping rate k . Next, at time $t + 1$, another site is chosen, e.g. site $N - 2$, which is occupied by a particle. However, because there is a particle at site $N - 1$, no jump occurs at time $t + 2$. These dynamics continue as time progresses.

There are two physical quantities that are discussed in this study: density $[\rho_i(t)]$ and current density $[J_{i(i+1)}(t)]$. $\rho_i(t)$ is the average ensemble of particles that occupy a lattice site i at time t . $J_{i(i+1)}(t)$ is the average amount of jumping by particles from lattice site i to site $(i+1)$ at time t . The relationship between the density and the current density is given by the continuity equation, viz.:

$$\nabla \cdot J_{i(i+1)} = - \frac{\partial \rho_i(t)}{\partial t} \tag{1}$$

For the TASEP we can use the simple Euler method $\nabla \cdot J_{i(i+1)} = J_{i(i+1)}(t) - J_{(i-1)i}(t)$, so that the formal solution of Eq. (1) can be written as follows:

$$\rho_i(t+1) = \rho_i(t) - \int_0^t dt' [J_{i(i+1)}(t') - J_{(i-1)i}(t')] \tag{2}$$

As mentioned above, there are four phases of density for the TASEP that are of interest. These are low density (LD), high density (HD), coexistence phase (CP), and maximal current (MC). These four phases are shown in Figure 2.

In Figure 2, α and β are the constant input (at the entrance) and output (at the exit) rates, respectively. The former is the probability rate of particles entering the lattice sites through the entrance, whereas the latter is

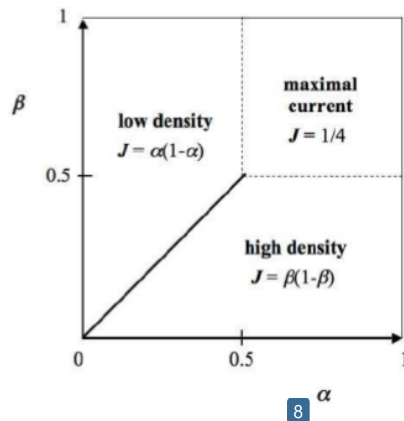

Figure 2. The Phase Diagram of the TASEP, with Open Boundary Conditions and Sequential Updating Dynamics

the probability rate of particles exiting the lattice sites. The LD phase is obtained for $\alpha < \beta$ and $\alpha < 0.5$. The HD phase is obtained for $\alpha > \beta$ and $\beta < 0.5$. The CP (diagonal line in Figure 2) between high and low densities is obtained for $\alpha = \beta$ and $\alpha, \beta < 0.5$. Finally, the MC phase yields the maximum current density value, which is $J = 0.25$. This latter phase occurs if $\alpha, \beta \geq 0.5$.

An equally important but lesser-known model is the TASEP extended to two dimensions (2D) [13,14]. The spatial extension of the model is important in modeling various transport systems that occur in the real world, such as road traffic at junctions, where vehicles can be considered as interacting particles. The movement of particles is still asymmetric (i.e., the particles may only jump to the right or to the upper sites). In this study, two cases are considered, that is i) a junction with two inputs (entrances) and one output (exit), where the input rates of particles are α_1 and α_2 , and the output rate is β_1 [Figure 3(i)], and ii) a junction with one input and two outputs [Figure 3(ii)], where the input rate is α_1 and the output rates are β_1 and β_2 . The values of these input and output rates will determine the density and current density of particles in each system case.

The sequential update of the TASEP in 2D at each time step $t \rightarrow t + 1$ (discrete time) can be described as follows. A lattice site $\mathbf{i} = i_x \hat{\mathbf{e}}_x + i_y \hat{\mathbf{e}}_y = (i_x, i_y) \in L^2$ is chosen randomly with probability $1/[N(N+2)]$, where L^2 is the 2D lattice system, N is the total number of lattice sites on the x - or y -axis, $\hat{\mathbf{e}}_x$ and $\hat{\mathbf{e}}_y$ are the unit vectors for the x - and y -axis, respectively. The current density of the TASEP in 2D can be written as [11, 15]:

$$J_{i(i+\hat{\mathbf{e}}_x)}^r(t) = k_{i(i+\hat{\mathbf{e}}_x)}^r(t) \rho_i(t) [1 - \rho_{i(i+\hat{\mathbf{e}}_x)}(t)], \quad (3)$$

and

$$J_{i(i+\hat{\mathbf{e}}_y)}^u(t) = k_{i(i+\hat{\mathbf{e}}_y)}^u(t) \rho_i(t) [1 - \rho_{i(i+\hat{\mathbf{e}}_y)}(t)], \quad (4)$$

where $J_{i(i+\hat{\mathbf{e}}_x)}^r(t)$ is the current density of particles moving from site \mathbf{i} to site $(\mathbf{i} + \hat{\mathbf{e}}_x)$, $J_{i(i+\hat{\mathbf{e}}_y)}^u(t)$ is the current density of particles moving from site \mathbf{i} to site $(\mathbf{i} + \hat{\mathbf{e}}_y)$, $k_{i(i+\hat{\mathbf{e}}_x)}^r$ is the hopping rate of particles from site \mathbf{i} to site $(\mathbf{i} + \hat{\mathbf{e}}_x)$ and $k_{i(i+\hat{\mathbf{e}}_y)}^u$ is the hopping rate of particles from site \mathbf{i} to site $(\mathbf{i} + \hat{\mathbf{e}}_y)$.

To obtain the density profiles of the TASEP in 2D, a continuity equation similar to Eq. (1) is used, such that an analogy to Eq. (1) for the TASEP in 2D is in order. To create an analogy with Eq. (1) the evolution of

particle density is obtained by using a continuity equation in 2D given as:

$$\frac{\partial \rho_i(t)}{\partial t} = \frac{1}{N(N-2)} \left\{ J_{i(i-\hat{\mathbf{e}}_x)}^r(t) - J_{i(i+\hat{\mathbf{e}}_x)}^r(t) + J_{i(i-\hat{\mathbf{e}}_y)}^u(t) - J_{i(i+\hat{\mathbf{e}}_y)}^u(t) \right\}. \quad (5)$$

It can be observed that the density, ρ , assigns the same index i on the left- and right-hand sides of Eq. (5). Consequently, Eq. (5) is not a closed equation, and has to be solved self-consistently. The specifications of the input and output rates determine the density and current density profiles obtained. By using this model system, we can study a realistic system for vehicles at a three-way junction.

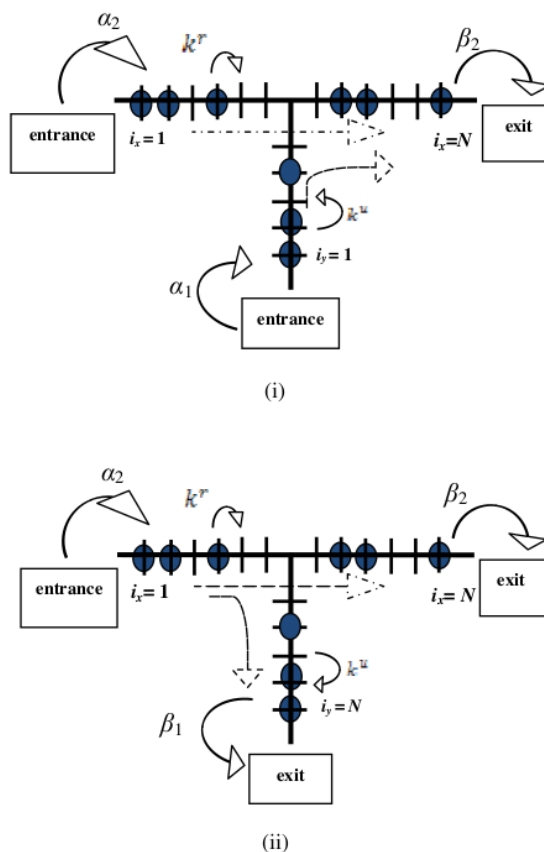

Figure 3. The Dynamics of TASEP in 2D for a Three-way Junction with (i) two Entrances and One Exit, and (ii) One Entrance and Two Exits

2. Methods

The instruments used in this research are (i) one (1) unit computer, (ii) Dev C++ software (language program), and (iii) MS Excel software.

The data collected for this study were obtained by running a computer code and varying the parameters. The parameters which were varied are i) $\alpha_1 = \alpha_2, \beta_2$ for the case of a junction with two inputs and one output, and ii) $\alpha_1, \beta_1 = \beta_2$ for the case of a junction with one input and two outputs. An additional constraint was also put forward, so that two of the input rates were the same and two of the output rates were the same, in case i) and case ii), respectively. This was done in order to reduce the number of parameters, so that the model would become simple and tractable. The input and output rates can be varied from 0.0 to 1.0.

The hopping rates, k' and k'' , were set as constant parameters. These were given values of 1.0, or $k' = k'' = 1.0$, for all lattice sites, except at the junction. This means that a particle on a site (except at the junction site) is certain to jump to the nearest right or higher neighbor site (probability of 1.0). A particle on the junction site can jump to the nearest right or higher neighbor with equal probability. As the probability is normalized, the hopping rate at the junction is set as $k' = k'' = 0.5$.

Finally, the values of the above mentioned parameters were inserted into equations (3), (4), and (5). The simple Euler method was then used to solve the differential equation (5) in the form of a computer code, via DEV C++. As Eq. (5) is a self-consistent equation, the main program code starts by providing a set of guess densities, ρ . The guess density set is then inserted into the right-hand side of Eq. (5), such that a new set of densities is obtained. The new set of densities is then inserted back into the right-hand side of Eq. (5), so on, until the result converges to the true solution for the

density. The current density profiles are obtained by inserting the true values of density into Eqs. (3) and (4).

3. Results and Discussion

The particle density for the TASEP in 2D in the form of a three-way junction has six kinds of phases, that is, high density-high density (HD-HD), coexistence phase-high density (CP-HD), low density-coexistence phase (LD-CP), low density-low density (LD-LD), maximal current-low density (MC-LD), and high density-maximal current (HD-MC). An example of a density profile for CP-HD is given in Figure 4 below.

Figure 4 presents a density profile for a three-way junction with two input rates and one output rate, obtained for $\alpha_1 = \alpha_2 = 0.1$ and β_2 . From the beginning of the lattice sites (horizontal axis), the density is low, at about 0.1. However, at site 20, the density abruptly changes to a high density of 0.9. At the junction site (site 50), the density decreases slightly to 0.8, but is still in the high density region. Hence, the phase is a combination of a coexistence phase (from site 1 to 50) and a high density phase (from site 50 to 100) or CP-HD.

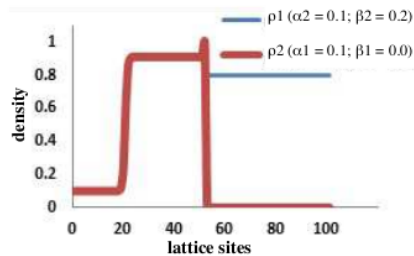

Figure 4. A Density Profile of the TASEP in 2D for a Three-way Junction with Two Entrances and One Exit, in the CP-HD Phase. The Horizontal Axis Presents the Lattice Sites from 1 to 100. The Vertical Axis is the Density with Numerical Values from 0.0 to 1.0

Table 1. Various Phases of the TASEP with two Input Rates $\alpha_1 = \alpha_2$ and one Output Rate β_2

$\alpha_1 \backslash \beta_2$	0.1	0.2	0.3	0.4	0.5	0.6	0.7	0.8	0.9	1.0
0.1	HD-HD	HD-HD	HD-HD	HD-HD	HD-HD	HD-HD	HD-HD	HD-HD	HD-HD	HD-HD
0.2	CP-HD	HD-HD	HD-HD	HD-HD	HD-HD	HD-HD	HD-HD	HD-HD	HD-HD	HD-HD
0.3	CP	HD-HD	HD-HD	HD-HD	HD-HD	HD-HD	HD-HD	HD-HD	HD-HD	HD-HD
0.4	LD-LD	HD-HD	HD-HD	HD-HD	HD-HD	HD-HD	HD-HD	HD-HD	HD-HD	HD-HD
0.5	LD-LD	HD-MC	HD-MC	HD-MC	HD-MC	HD-MC	HD-MC	HD-MC	HD-MC	HD-MC
0.6	LD-LD	HD-MC	HD-MC	HD-MC	HD-MC	HD-MC	HD-MC	HD-MC	HD-MC	HD-MC
0.7	LD-LD	HD-MC	HD-MC	HD-MC	HD-MC	HD-MC	HD-MC	HD-MC	HD-MC	HD-MC
0.8	LD-LD	HD-MC	HD-MC	HD-MC	HD-MC	HD-MC	HD-MC	HD-MC	HD-MC	HD-MC
0.9	LD-LD	HD-MC	HD-MC	HD-MC	HD-MC	HD-MC	HD-MC	HD-MC	HD-MC	HD-MC
1.0	LD-LD	HD-MC	HD-MC	HD-MC	HD-MC	HD-MC	HD-MC	HD-MC	HD-MC	HD-MC

Table 1 shows various density phases, which depend on the input rates $\alpha_2 = \alpha_2$ and output rate β_2 from 0.1 to 1.0, or in other words, from HD-HD to LD-LD. For $\alpha_2 = \alpha_1 > 0.1$ with output rate β_2 variation from 0.1 to 1.0, a phase transition from HD-HD to HD-MC occurs. For $\alpha_2 = \alpha_1 = 0.1; \beta_2 = 0.1$, the HD-HD density phase occurs. For $\alpha_2 = \alpha_1 = 0.1; \beta_2 = 0.2$, the CP-HD phase occurs. As the output rate is increased to $\beta_2 = 0.3$, the LD-CP phase occurs. For $\beta_2 > 0.3$, a transition to the LD-LD phase takes place. For $\alpha_2 = \alpha_1 > 0.1; 0.1 < \beta_2 < 0.5$, the HD-HD phase occurs. Finally, for $\alpha_2 = \alpha_1 > 0.1; \beta_2 \geq 0.5$, the density profile indicates the HD-MC phase.

The next case involves a three-way junction of the TASEP in 2D with one entrance (one input rate) and two exits (two output rates). A phase diagram of various phases for this case, in which $\beta_1 = \beta_2$, can be seen in Table 2. Various phase transitions are evident in the table. The first phase is again LD-LD, when $\alpha_1 = 0.1; \beta_1 = \beta_2 = 0.1$. If α_1 is increased to 0.2, but β_1, β_2 remains fixed, the phase changes to LD-CP. Then, if α_1 is increased to 0.3, the density phase of CP-HD is produced. If the input rate is in the range of 0.4 to 1.0, with $\beta_1 = \beta_2 = 0.1$, the density reaches a high density phase, which is HD-HD. The high density phase can then be decreased by increasing the values of β_1, β_2 . For $0.4 \leq \alpha_1 \leq 0.5$, if $\beta_1 = \beta_2$ is increased, the LD-LD phase will be obtained. For $0.6 \leq \alpha_1 \leq 1.0$, the density phase becomes MC-LD. According to these results, the LD-LD phase occurs if $\alpha_1 = \beta_1 = \beta_2 = 0.1$ and $\alpha_1 \leq 0.5, \beta_1 = \beta_2 \geq 0.2$. The LD-CP phase then occurs if $\alpha_1 = 0.2, \beta_1 = \beta_2 = 0.1$. Next, the CP-HD phase occurs for $\alpha_1 = 0.3, \beta_1 = \beta_2 = 0.1$. The HD-HD phase occurs for $\alpha_1 \geq 0.4; \beta_1 = \beta_2 = 0.1$. Finally, the MC-LD phase occurs for $\alpha_1 \geq 0.6, \beta_1 = \beta_2 \geq 0.2$.

An example of a density profile for the three-way junction with one entrance and two exits is presented in Figure 5. The CP starts from the beginning of the lattice site and continues until the junction site. Then, from the junction site until both ends of the lattice sites, the HD phase occurs. As such, the combination of the phases is

CP-HD. For this case, the input rate is 0.3, and the output rates are both 0.1. Without the junction (only one output rate), the phase would be HD. However, the additional lane (junction) reduces the high density profile of the first half of the lattice sites to CP.

Some comparison between the two cases above is in order. In general, the density of particles in the three-way junction with two entrances (two input rates) and one exit (one output rate) is higher than in the three-way junction with one entrance and two exits. This is in accordance with the boundary conditions enforced for the two cases above, where the former has more entrances and fewer exits than the latter. If the particles that move through the three-way junction are regarded as models of vehicles, this demonstrates that the vehicular traffic in a lane with two entrances and one exit will be at a high density for most given input and output rates. This can also be observed in Table 1. Likewise, if the three-way junction has one entrance and two exits, the vehicular traffic will be at a low density in the dominant scenario, which can be seen in Table 2.

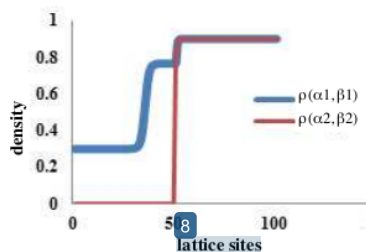

Figure 5. The Density Profile of the TASEP in 2D for a Three-way Junction with One Entrance and Two Exits in the CP-HD Phase. The Horizontal Axis Presents the Lattice Sites from 1 to 100. The Vertical Axis is the Density

Table 2. Various Phases for a Three-way Junction with one Input rate (α_1) and Two Output Rates (β_1, β_2)

$\alpha_1 \backslash \beta_1$	0.1	0.2	0.3	0.4	0.5	0.6	0.7	0.8	0.9	1.0
0.1	LD-LD	LD-CP	CP-HD	HD-HD	HD-HD	HD-HD	HD-HD	HD-HD	HD-HD	HD-HD
0.2	LD-LD	LD-LD	LD-LD	LD-LD	LD-LD	MC-LD	MC-LD	MC-LD	MC-LD	MC-LD
0.3	LD-LD	LD-LD	LD-LD	LD-LD	LD-LD	MC-LD	MC-LD	MC-LD	MC-LD	MC-LD
0.4	LD-LD	LD-LD	LD-LD	LD-LD	LD-LD	MC-LD	MC-LD	MC-LD	MC-LD	MC-LD
0.5	LD-LD	LD-LD	LD-LD	LD-LD	LD-LD	MC-LD	MC-LD	MC-LD	MC-LD	MC-LD
0.6	LD-LD	LD-LD	LD-LD	LD-LD	LD-LD	MC-LD	MC-LD	MC-LD	MC-LD	MC-LD
0.7	LD-LD	LD-LD	LD-LD	LD-LD	LD-LD	MC-LD	MC-LD	MC-LD	MC-LD	MC-LD
0.8	LD-LD	LD-LD	LD-LD	LD-LD	LD-LD	MC-LD	MC-LD	MC-LD	MC-LD	MC-LD
0.9	LD-LD	LD-LD	LD-LD	LD-LD	LD-LD	MC-LD	MC-LD	MC-LD	MC-LD	MC-LD
1.0	LD-LD	LD-LD	LD-LD	LD-LD	LD-LD	MC-LD	MC-LD	MC-LD	MC-LD	MC-LD

The computed results for the current density are in the form of graphs of current density vs. lattice sites. The current densities may be obtained by using Eq. (3) and Eq. (4), after Eq. (5) is solved numerically. As explained above, the current density describes the average hopping of particles through the three-way junction. An example of a current density profile is given in Figure 6. The figure shows a current density profile for $\alpha_1 = 0.4; \beta_1 = \beta_2 = 0.1$.

Clearly, the current density profile of the three-way junction depends on $\alpha_1, \alpha_2, \beta_1,$ and β_2 . The profile is mainly flat throughout the lattice sites. This indicates that the value of the current density is constant. Furthermore, this shows that the three-way junction is in a steady state of non-equilibrium. However, the value of the current density from the beginning to the junction site is higher than for the rest of the lattice sites.

Figure 7 depicts the current density profile of a three-way junction for $\alpha_1 = 0.3; \beta_1 = \beta_2 = 0.1$. The profile is

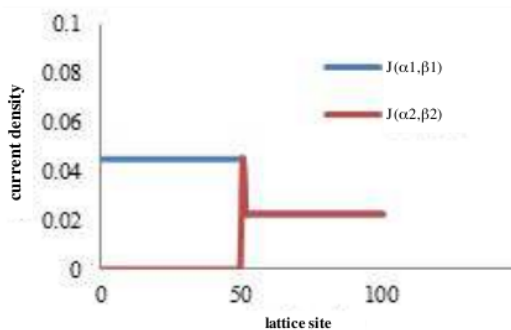

Figure 6. Current Density Profile with $\alpha_1 = 0.4; \beta_1 = \beta_2 = 0.1$

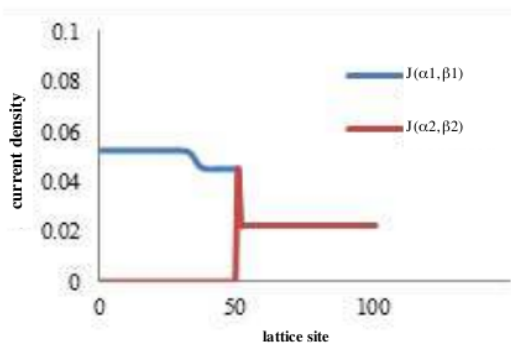

Figure 7. The Current Density Profile of the Three-way Junction with $\alpha_1 = 0.3; \beta_1 = \beta_2 = 0.1$

similar to the previous density profile, and is flat throughout the lattice sites. However, the value of the current density lowers from the beginning to the end of the lattice sites.

4. Conclusions

Based on the results and discussion above, the findings of this study can be summarized as follows. The two cases of the three-way junction of the TASEP in two dimensions produce various phases, which are HD-HD, CP-HD, LD-CP, LD-LD, and HD-MC. The MC-LD phase especially occurs for the three-way junction with one input and two outputs.

In general, the density profile of the three-way junction with two inputs and one output is higher than that of the three-way junction with one input and two outputs. The current density profiles are determined by the specifications of $\alpha_1, \alpha_2, \beta_1,$ and β_2 . The value of the current density is constant, which shows that the systems are in steady non-equilibrium states.

Acknowledgements

The authors would like to thank the Faculty of Mathematics and Natural Sciences Universitas Negeri Yogyakarta for the funding of this research under the Faculty DIPA grant No. 023-04.2.189946/2013.

References

- [1] C.M. van Vliet, Equilibrium and Non-Equilibrium Statistical Mechanics, World Scientific, Singapore, 2008, p.992.
- [2] R. Zwanzig, Nonequilibrium Statistical Mechanics, Oxford University Press, Oxford, 2001, p.240.
- [3] B. Derrida, E. Domany, D. Mukamel, J. Stat. Phys. 69 (1992) 667.
- [4] A. Parmeggiani, T. Franosch, E. Frey, Phys. Rev. E 70 (2004) 046101.
- [5] C. MacDonald, J. Gibbs, A. Pipkin, Biopolymers 6 (1968) 1.
- [6] A. Pipkin, J. Gibbs, Biopolymers 4 (1966) 3.
- [7] D. Chowdury, Traffic Flow of Interacting Self-Driven Particles: Rails and Trails Vehicles and Vesicles, Kanpur, Indian Institute of Technology, 2003, p.7.
- [8] D. Chowdury, A. Schadschneider, K. Nishihari, Phys. Life Rev. 2 (2005) 319.
- [9] H. Hirsch, E. Frey, Phys. Rev. Lett. 97 (2006) 095701.
- [10] H. Hirsch, R. Kouyos, E. Frey, From Intracellular Traffic to a Novel Class of Driven Lattice Gas Models, Traffic and Granular Flow 2005, Chapter II, Springer, 2006, p.205.

- [11] W.S.B. Dwandaru, Ph.D Thesis, Faculty of Science, University of Bristol, United Kingdom, 2010.
- [12] W.S.B. Dwandaru, M.Sc. Thesis by Research Dissertation, Faculty of Science, University of Bristol, United Kingdom, 2006.
- [13] D.P. Foster, C. Godreche, J. Stat. Phys. 76 (1994) 1129.
- [14] K. Ravishankar, Stochastic Process. Appl. 43 (1992) 223.
- [15] W.S.B. Dwandaru, M. Schmidt, J. Phys. A: Math. Gen. 37 (2007) 9907.

ORIGINALITY REPORT

24%

SIMILARITY INDEX

23%

INTERNET SOURCES

7%

PUBLICATIONS

9%

STUDENT PAPERS

PRIMARY SOURCES

1

bristol.ac.uk

Internet Source

8%

2

tel.archives-ouvertes.fr

Internet Source

3%

3

worldwidescience.org

Internet Source

3%

4

www.clank1.com

Internet Source

2%

5

www02.us.archive.org

Internet Source

1%

6

portalgaruda.ilkom.unsri.ac.id

Internet Source

1%

7

Submitted to iGroup

Student Paper

1%

8

seminar.uny.ac.id

Internet Source

1%

9

Submitted to Universiti Sains Malaysia

Student Paper

1%

10

www.phoenix.edu

Internet Source

<1%

11

asa.lib.lehigh.edu

Internet Source

<1%

12

iopscience.iop.org

Internet Source

<1%

13

Takahiro Tannai, Katsuhiko Nishinari.

"Theoretical approach to congestion relaxation and saturated congestion in TASEP (totally asymmetric simple exclusion process) network with multi-chain section with flow/density-dependent rules of junctions", Physics Letters A, 2017

Publication

<1%

14

arxiv.org

Internet Source

<1%

15

imentaraddod.com

Internet Source

<1%

16

Yu-Qing Wang, Zi-Huan Zhang, Bing-Hong

Wang. "Non-equilibrium phase transition in the heterogenous TASEPs with binding and unbinding processes among the adjacent subsystems", Chaos, Solitons & Fractals, 2020

Publication

<1%

17

export.arxiv.org

Internet Source

<1%

18

nbn-resolving.de

Internet Source

<1%

Exclude quotes Off

Exclude matches Off

Exclude bibliography On